



“Let your light shine.”
Matthew 5:16

Bright • *Bright* • April Week 2

Copy on cardstock and cut. One per child.

CURRICULUM FOR 3-5-YEAR-OLDS • ©2024 The reThink Group. All rights reserved. • www.ThinkOrange.com

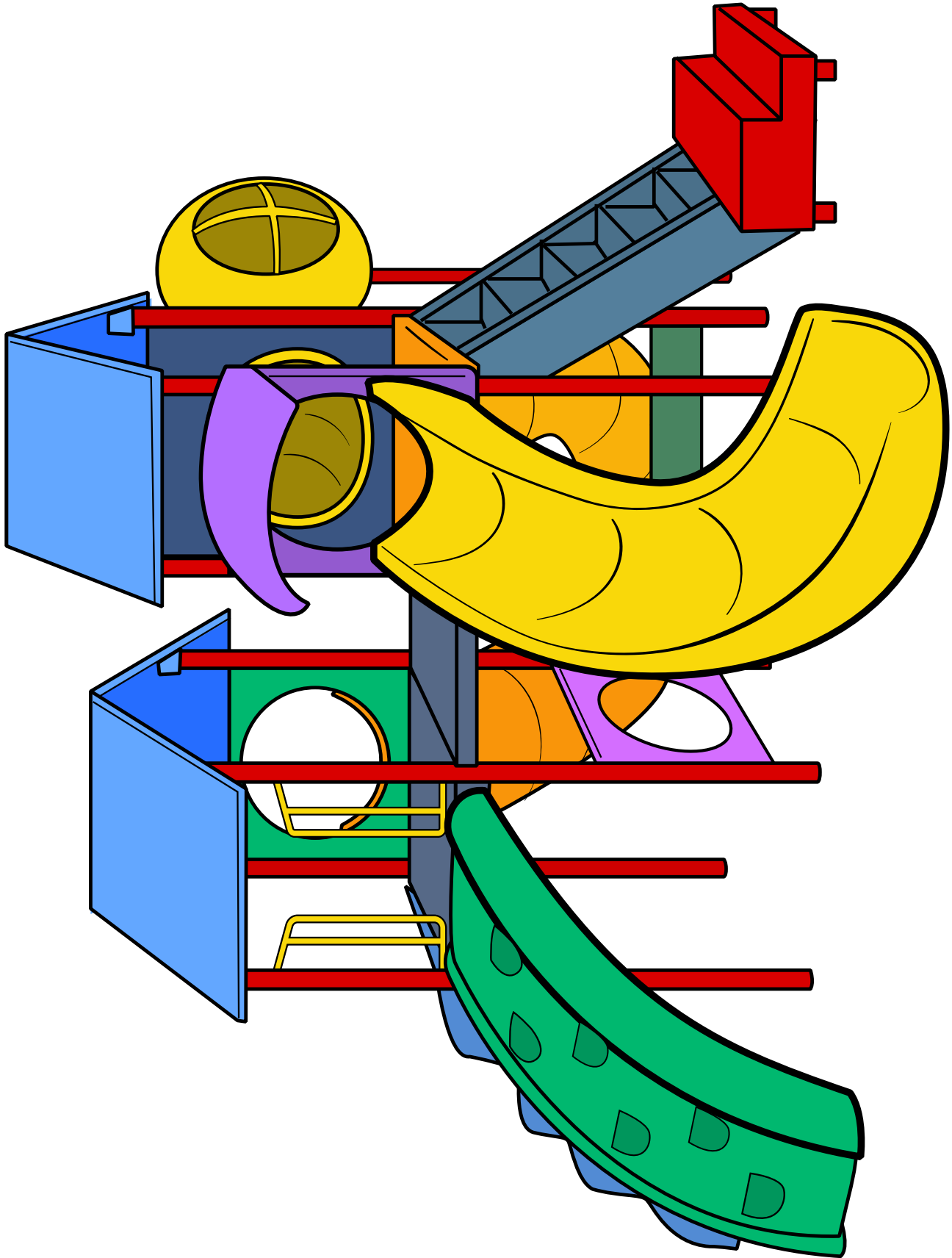

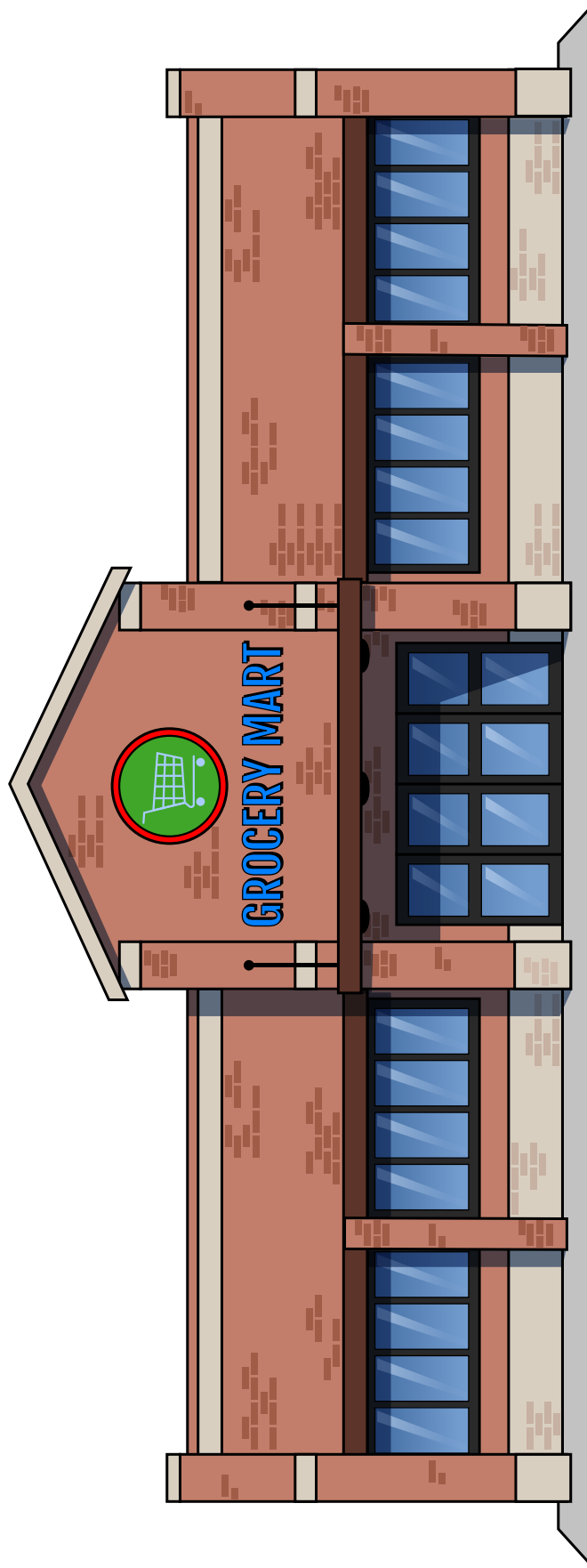





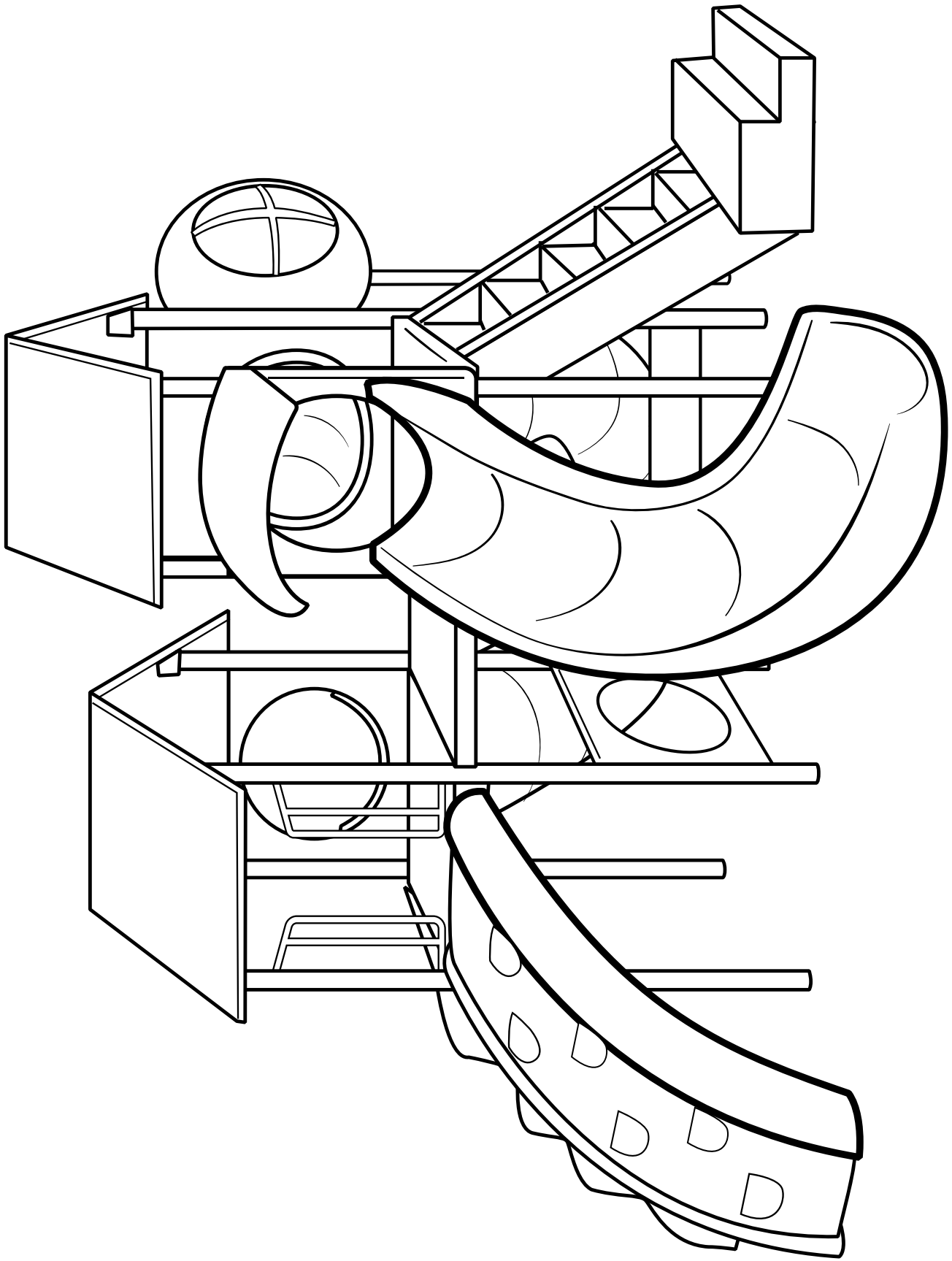

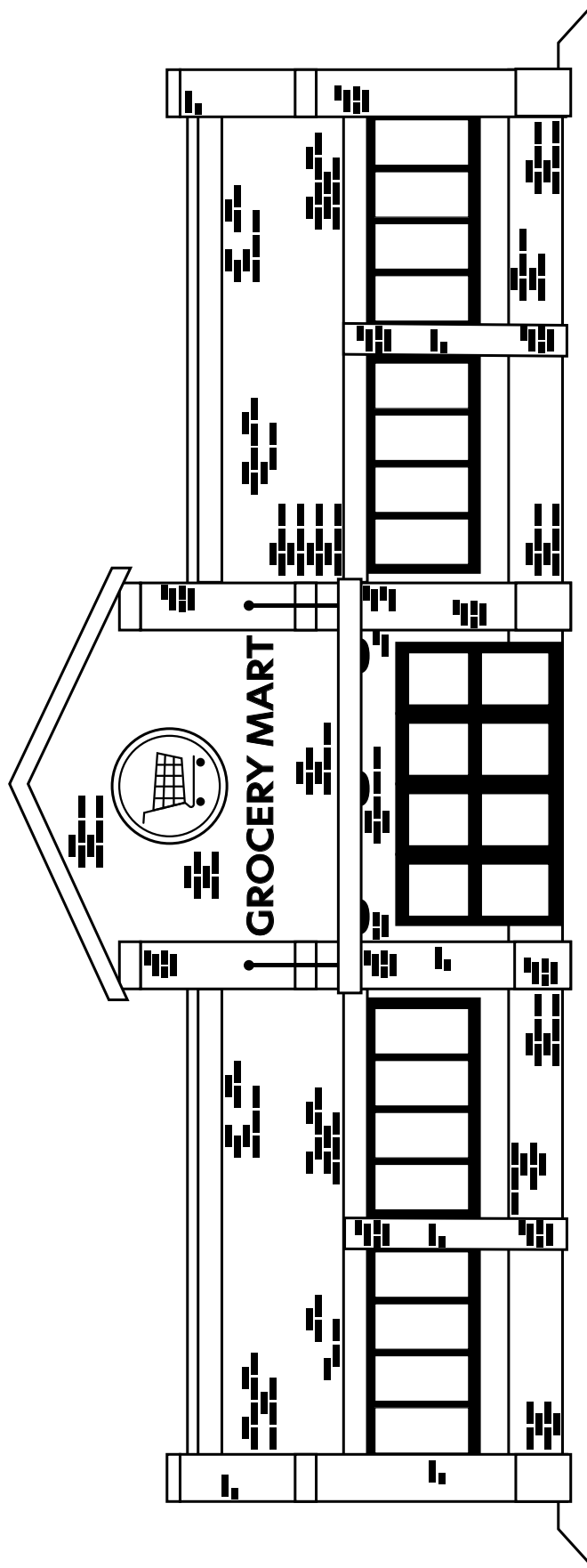

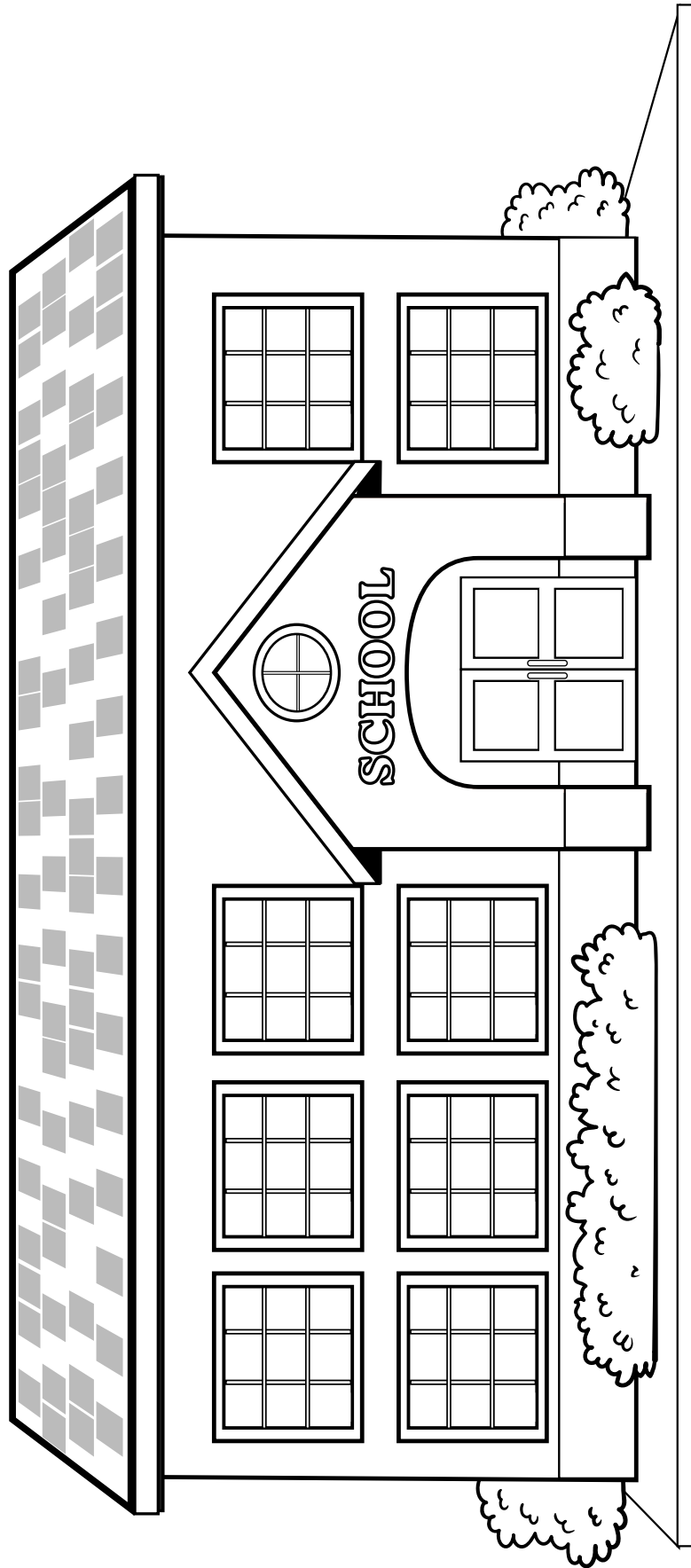

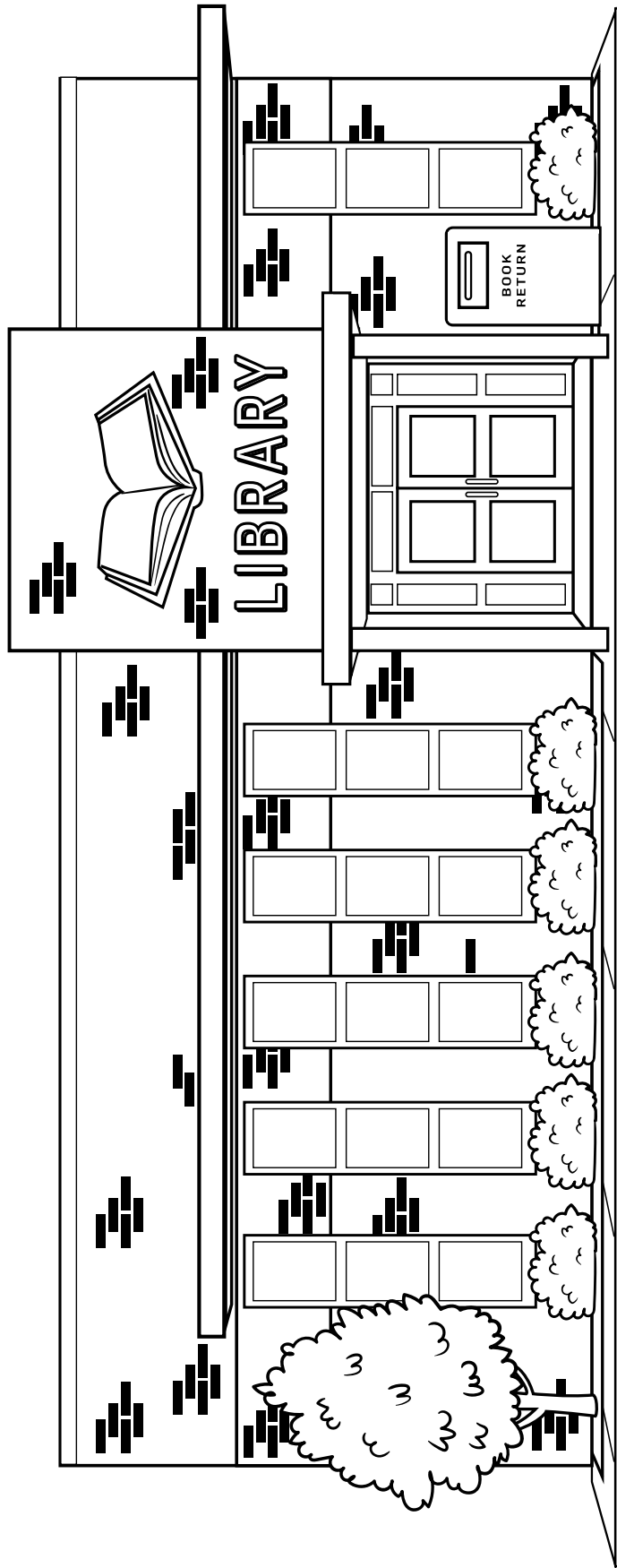

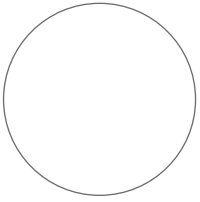

**Jesus wants
to be my
friend
forever.**

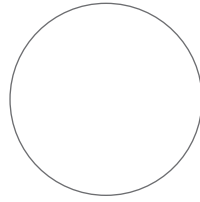

**Jesus wants
to be my
friend
forever.**

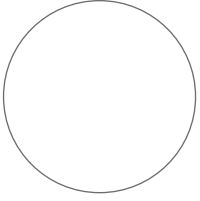

**Jesus wants
to be my
friend
forever.**

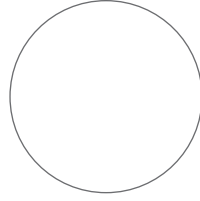

**Jesus wants
to be my
friend
forever.**



THIS ROW OF LABELS INTENTIONALLY LEFT BLANK

